

MegaPulse

IMPULSE TESTER

968-B Power Line

Instruction Manual

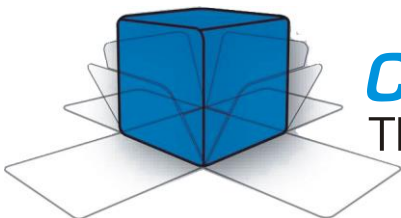

COMPLIANCE WEST USA

The blue box that tests. And tests.



i

Dear Customer:

Congratulations! Compliance West USA is proud to present you with your MegaPulse Power Line Impulse Tester. Your instrument features a groundbreaking logic-controlled circuit design and ergonomic front panel and represents the latest in high voltage impulse testing.

To fully appreciate all the features of your new instrument, we suggest that you take a few moments to review this manual. Compliance West USA stands by your instrument with a full one-year warranty. If the need arises, please don't hesitate to call on us.

Thank you for your trust and confidence.

Rev 0, July 2018

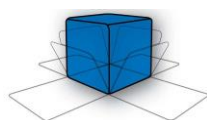



Table of Contents

Section 1	1
An Introduction to Impulse Testing with the MegaPulse series tester	1
Safety Precautions	1
Test Personnel	1
Testing Area	1
Safety Techniques	2
Safety Markings	2
Using the MegaPulse Impulse Tester	3
Section 2	1
Getting Started	1
Unpacking and Inspection	1
Packaging	1
Product Package for 968-B Power Line Tester	1
Returning the Instrument	1
AC Line Voltage Requirements	2
Fuse Replacement	2
Section 3	3
Specifications and Controls	3
Front and Rear Panel Features	4
Section 4	7
Operating Instructions	7
External Interlock	7
Front Keyboard and Voltage Knob Enable	7
Discharging Residual Voltage	7
Voltage Set Point Adjustment	8
Charge and Trigger a Pulse	8
Pulse Verification Procedure	8
Section 5	10
Maintenance and Calibration	10
Service Information	10
General Maintenance	10
Cleaning	10
Performance Test and calibration verification	10
Section 6	12
Technical Assistance	12





v

Section 1

An Introduction to Impulse Testing with the MegaPulse series tester

The impulse test is designed to simulate impulse surges which occur in everyday life due to nearby lightning strikes, switching transients, and other high-frequency faults on the power distribution network. Impulse testing is the fundamental method for empirical verification of the adequacy of insulation. Other methods of ensuring adequate insulation (AC or DC Dielectric Withstand testing, measurement of over-surface creepage, through-air clearance, or distance-through-insulation) are all extrapolated from the results of impulse testing. The impulse test is performed to ensure that the insulation in question will be able to function properly when subjected to similar impulse surges in the field.

Safety Precautions

The impulse withstand test can generate voltages in excess of 2500 V peak at potentially lethal current levels. Currents of as little as 5 mA at 120 volts can cause death; the MegaPulse can deliver currents of more than 1000 Amps peak for a very short time duration. The potential for serious injury or death exists and personnel should be aware when they conduct this test.

Test Personnel

Personnel require special training to conduct the impulse test. They should understand electrical fundamentals clearly and be aware that high voltage is adept and creative at completing a path to ground. Instructions should include a warning against any metal jewelry. Operators should not allow others in the testing area, especially when tests are being conducted. Organization is to be stressed. The operator should keep the area free of unused leads and equipment.

Testing Area

The area used for conducting the impulse test should be as remote as possible from normal production line activities. Only personnel conducting the test should be allowed in the area, and it should be taped or roped off to preclude casual entry by other employees. In addition, the area should be marked "WARNING - HIGH VOLTAGE TESTING" or the equivalent to warn others of the nature of the testing taking place.

The bench being used should be non-conductive, and any exposed metal parts should be tied together and grounded. If a conductive surface must be used, it should be grounded. Because of sparking during an impulse test failure, it is not safe to conduct impulse testing in combustible atmospheres.

It is imperative that a good ground be provided to the MegaPulse tester. Before connecting the equipment, ensure that the building wiring provides a low-resistance ground. If the MegaPulse tester is used on a high-resistance grounding circuit, dangerous high voltages may be present to the operator. In addition, the power to the Testing Area should be provided with an easily reached shutoff switch which can be actuated by personnel outside the Area if needed.

CAUTION: Plug on power cord is disconnect device. The power to the Testing Area should be provided with an **easily reached shutoff switch** which can be actuated by personnel outside the area if needed.





Safety Techniques

The high voltage circuit of the MegaPulse can be shut off at any time by turning OFF the rear power switch. Note that there are residual voltages inside the equipment that may take up to 85 minutes to bleed off to safe levels. Always press TRIGGER to discharge the tester before turning OFF.









The MegaPulse tester is provided with a digital **VOLTAGE ADJUST** knob on the front panel. This voltage setting should always be confirmed by pressing the VOLTAGE ADJUST knob before starting any test.

The MegaPulse tester is provided with a **CHARGE** switch that is in the unarmed "Standby" setting when the tester is first turned ON. When the yellow **CHARGE** button is lit, the tester will not provide high voltage until the **CHARGE** Button and the **TRIGGER** Button have been pressed in order. To prevent inadvertent operation, the operator should be instructed not to press the **CHARGE** Button until the test is ready.

The MegaPulse tester has been designed for one-touch operation with the right hand. If possible, it should be set up to the left and in front of the equipment under test. The equipment under test should be connected to the MegaPulse tester and then left alone by the operator. After the operator is clear of the tester and the equipment under test, the operator should turn the rear-panel power switch to ON, press the **CHARGE** Button, adjust the voltage to the desired level (as displayed on the front panel meter), then press the **TRIGGER** Button, with his right hand. This will allow the greatest separation between the operator and the test being conducted.

The MegaPulse tester is designed to bleed the high voltage away after the test has concluded. To ensure that any voltage present in the equipment being tested has been completely bled away, the operator should not unplug the equipment under test from the MegaPulse until the front panel meter reads a safe level (40 volts or less is generally considered a safe level). Pressing the TRIGGER button before disconnecting main power (or turning the equipment off) will ensure that the internal capacitors are discharged as much as possible.

Safety Markings

	Direct Current		On (Power)
	Alternating Current		Off (Power)
	Refer to instructions		Caution, possibility of electric shock
	Earth (ground) TERMINAL		High Voltage



Using the MegaPulse Impulse Tester

The impulse test involves high voltage and caution should be exercised when using the tester. The **RETURN** lead is referenced to building ground when properly connected. However, the **OUTPUT** and **RETURN** leads must always be treated as Hazardous whenever the power switch of the MegaPulse is in the ON position.

The MegaPulse impulse tester generates the impulse waveform only; it does not determine Passing or Failing results. It is the operator's responsibility to monitor the output waveform and determine Passing or Failing results. In monitoring the impulse waveform, consider the following points:

The Impulse waveform is high voltage, and high frequency (short duration). Always ensure that the measuring instrument (usually an oscilloscope with a high-voltage probe) is rated for the voltage involved, and that the frequency response of the instrument and probe are capable of measuring the output waveform of the MegaPulse Impulse Tester. A measuring instrument or probe with a low frequency response will result in erroneous readings that could be mis-read.

Pressing the **POLARITY** switch on the front panel can change the polarity of the output waveform. The polarity is Normal when the **NOR** indicator is lit. In this case, the high voltage will appear on both **OUTPUTS** as a positive pulse relative to the **RETURN** jack. When the polarity switch is in the Reverse position (**REV** indicator is lit), the high voltage will appear on both **OUTPUTS** as a negative pulse relative to the **RETURN** jack. The polarity switch only operates when the **CHARGE LED** is lit, i.e. the output is not charged.

Note that the voltage meter may indicate that some residual voltage is present on the main storage capacitor, even when the tester is first turned ON. This is due to inherent charging of the internal capacitors. Pressing the **TRIGGER** switch will discharge the capacitors (be sure not to touch the output and return leads when pressing the trigger switch).

Note that the peak amplitude of the measured output waveform is proportional to the voltage that is read on the front panel of the MegaPulse. Therefore, it is important to measure the peak amplitude of the output waveform and adjust the output of the MegaPulse accordingly.

Determination of Passing and Failing results can prove difficult. To obtain the most accurate results, it is generally necessary to perform multiple impulse tests on a few different test samples (that have adequate insulation to pass the impulse test). Take note of the impulse waveshape, amplitude, and duration. Also note how much variance there is in the waveshape from test to test. Also (if possible), perform impulse testing on some test samples that are known to have inadequate (or damaged) insulation. Take note of the impulse waveshape, amplitude, and duration, when an insulation breakdown occurs.



Section 2

Getting Started

This manual contains complete operating, maintenance and calibration instructions for the Compliance West USA MegaPulse Power Line Impulse Tester.

Your tester is warranted for a period of one year upon shipment of the instrument to the original purchaser.

This section contains information for the unpacking, inspection, preparation for use and storage of your Compliance West product.

Unpacking and Inspection

Packaging

Your Tester is shipped in a special protective container that should prevent damage to the instrument during shipping. Check the shipping order against the contents of the container and report any damage or short shipment to Compliance West USA. Please save the shipping carton and packing material for the carrier's inspection. Our customer support department will assist you in the repair or replacement of your instrument. Please do not return your product without first notifying us and receiving an RMA (return material authorization) number. To receive an RMA number, please contact our customer support department at (1-800-748-6224).

Product Package for 968-B Power Line Tester

	Description	Part Number
968-B Power Line	MegaPulse Tester	
	User Manual	
	10AWG Banana to Alligator, Red (Qty 1)	
	10AWG Banana to Alligator, Black (Qty 1)	
	18 AWG AC Power Cord	70-101
TestMinder (Optional)	User Manual	
	Software CD	MegaPulse TestMinder P/PF
	RS232 cable	60-134
	USB box	00-USBDBOX
	USB cable	60-221

Returning the Instrument

When it's necessary to return the instrument for servicing or calibration, repackage the instrument in its original container, please include all accessories and test leads. Indicate the nature of the problem or type of service needed. Also, please mark the container as "FRAGILE" to insure proper handling.

If you do not have the original packaging materials, please follow these guidelines:

- Wrap the instrument in a bubble pack or similar foam including all the included cables.
- Use a strong double-wall container that is made for shipping instrumentation.
- Use a layer of shock absorbing material 70 to 100mm (3 to 4 inch) thick around all sides of the instrument. Protect the control panel with cardboard.
- Seal the container securely.
- Mark the container as "FRAGILE" to insure proper handling.



- Please contact Compliance West USA (1-800-748-6224) to inform about the service for your instrument.

AC Line Voltage Requirements

AC line voltage requirements for your Tester are noted on the rear panel of the instrument. Do not connect the instrument to a different voltage source. The cord packaged with your MegaPulse Tester is for use in the United States. If another power cord must be used, the cord must be rated for the maximum current noted on the rear panel. It must also meet the requirements of IEC 227 or IEC 245, and mains cords that are certified or approved by any recognized national test house are regarded as meeting this requirement.

Fuse Replacement

There is a user-replaceable fuse (F1) located on the rear panel of the instrument. It is located behind a door in the Power Inlet-Power Switch-Fuse Holder device. The fuse rating is noted on the rear panel. Do not attempt to replace it with a fuse of any other rating.

Use the following procedure to replace the fuse F1:

1. Turn the power switch to the OFF position.
2. Unplug the instrument from the source of supply.
3. Remove the power inlet cord from the instrument.
4. Using a small screwdriver, pry open the fuse holder door.
5. Replace the fuse with a new one of the correct rating.
6. Replace the fuse holder door and power inlet cord.



Section 3

Specifications and Controls

Specifications for the MegaPulse Power Line are listed below, and the waveform schematic is shown in Figure 1. (**Note:** other custom configurations are available from the factory).

Table 1 MegaPulse 968-B Power Line Specifications

<p>SPECIFICATIONS</p> <p>Waveshape reference:</p> <ul style="list-style-type: none"> - Voltage: TIA-968-B Fig.2. - Current: TIA-968-B Fig.3. <p>Voltage peak: 2500V minimum.</p> <p>Voltage Pulse Front Time: 1μs to 2μs (1.67 times between 30% and 90%), per TIA-968-B Fig.2.</p> <p>Voltage Pulse Decay Time: 10μs to 19μs, per TIA-968-B Fig.2.</p> <p>Current Peak: 1000A minimum.</p> <p>Current Pulse Front Time: 1μs to 2μs (1.25 times between 10% and 90%), per TIA-968-B Fig.3.</p> <p>Current Pulse Decay Time: 10μs to 19μs, per TIA-968-B Fig.3.</p> <p>ELECTRICAL</p> <p>Input Voltage: 120V~ 50-60 Hz, *Optional line voltage.</p> <p>Meter Voltage Accuracy: \pm3%.</p> <p>Voltage control: Digital Set point adjusted by front Voltage knob.</p> <p>Polarity control: Positive/Negative.</p> <p>ENVIROMENTAL</p> <p>Operating temperature: 15-40°C.</p> <p>Relative Humidity: 0-90% non-condensing.</p> <p>Altitude: 0-3000 meters.</p> <p>GENERAL</p> <p>Dimensions: 17" wide x 6" high x 17" deep.</p> <p>Weight: 30lbs. approximately.</p>
--

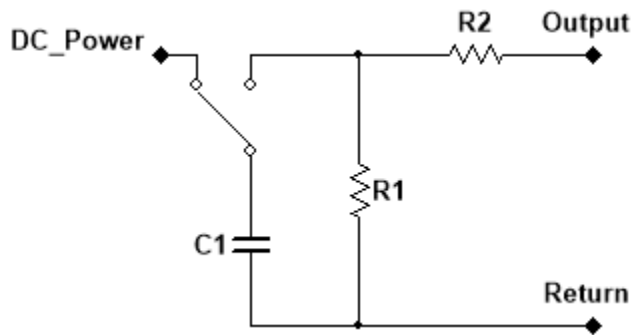

Figure 1 Power Line Waveform Circuit Schematic

Waveform*	Max. Voltage	C1	R1	R2
Open circuit: 2x10 μ s Short circuit: 2x10 μ s	2500V	11 μ F	2 Ω	2.2 Ω

* Complies with the requirements of TIA-968-B, Sec. 4.1.4



Front and Rear Panel Features

Before using your Tester, take a few minutes to become familiar with the use of its controls, indicators and connectors. The front panel features of the MegaPulse are shown in **Figure 2** and described in **Table 2**. The rear panel features of the MegaPulse are shown in **Figure 3** and described in **Table 3**.

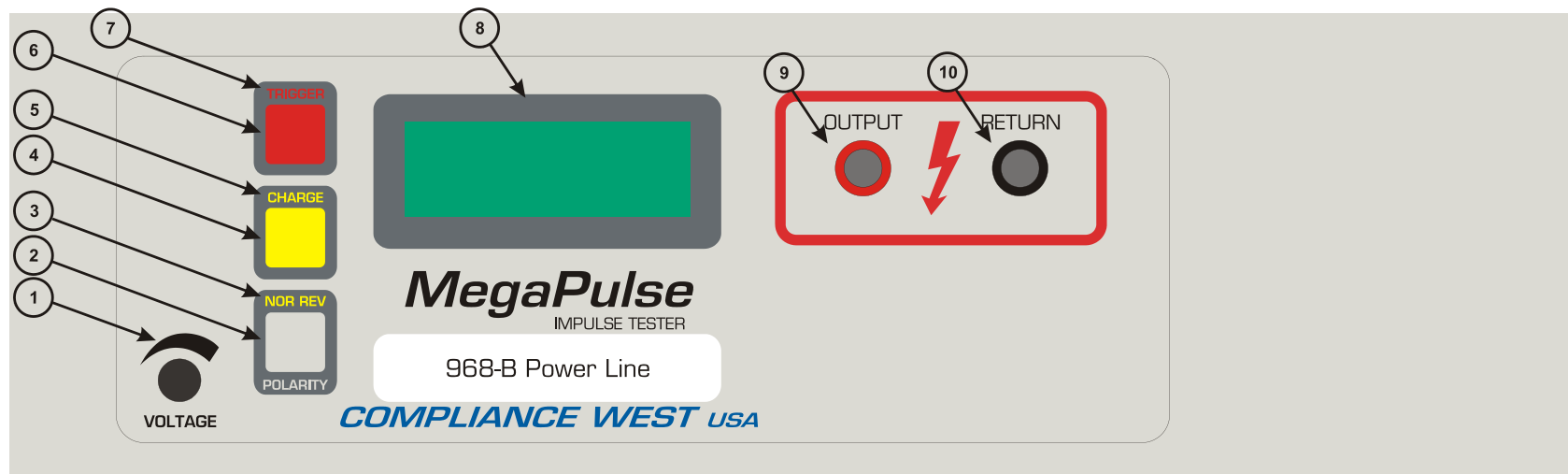
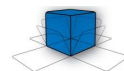

Figure 2 MegaPulse 968-B Power Line Front Panel



Table 2 MegaPulse 968-B Power Line Front Panel Features

ITEM	NAME	FUNCTION
1	VOLTAGE Adjust Knob	Adjust the digital voltage set point in the tester. Press the voltage knob to display the voltage set point. This setting will blink for a few seconds on the front meter. Turn Clockwise to increase the Voltage Setting Point before pressing CHARGE button.
2	POLARITY switch	Toggles the output pulse polarity from Normal to Reverse, Normal for positive and Reverse for Negative, The pulse will appear on the Output jack relative to the return jack The polarity switch only operates when the CHARGE indicator is lit and the voltage on the display meter is less than 180V. The polarity is normal when the NOR indicator is lit and reverse when the REV indicator is lid.
3	NOR REV indicator	Indicates the state of the Output Polarity switch. NOR indicates Normal (Positive) position. REV indicates Reverse (Negative) position.
4	CHARGE switch	Starts the charge process of the tester capacitor. The CHARGE indicator will turn off after the CHARGE switch is pressed, and the TRIGGER indicator will turn on. The charge process will stop after 2 minutes if the TRIGGER button is not pressed.
5	CHARGE indicator	This Yellow indicator is lit to show that pressing the CHARGE switch is the next logical step in a test sequence. CHARGE indicator is lit when the tester is turn ON an after pressing TRIGGER button. CHARGE indicator will go out after pressing CHARGE button. CHARGE and TRIGGER Indicators will be blinking if the Interlock Switch is open. (Only testers with Interlock Switch Option)
6	TRIGGER switch	Triggers the output impulse waveform. The impulse waveform will appear across the output leads.
7	TRIGGER indicator	This Red indicator is lit to show that the tester can be triggered. TRIGGER indicator is lit for 2 minutes after the CHARGE button is pressed. TRIGGER indicator will go out after pressing TRIGGER button.
8	VOLTAGE meter	Displays the output voltage set point. The voltage reading will increase from zero to the voltage set point when the CHARGE button is pressed. The meter will start to flash at 2600V to indicate that voltage is in the maximum limits. If unit includes PC Interface and the Keyboard is locked, the display will show OFF when a button is pressed.
9	OUTPUT jack	The impulse waveform appears on the OUTPUT jack, referenced to the RETURN jack. When the POLARITY switch is in the Normal position (NOR indicator is lit) the output will be a positive pulse. When the POLARITY switch is in the Reverse position (REV indicator is lit) the output will be a negative pulse.
10	RETURN jack	This is the return for the impulse waveform. This jack is referenced to the chassis of the MegaPulse and is referenced to earth ground as long as the MegaPulse is properly grounded. Even though this jack is referenced to ground, it should be treated as hazardous whenever the MegaPulse is turned ON.



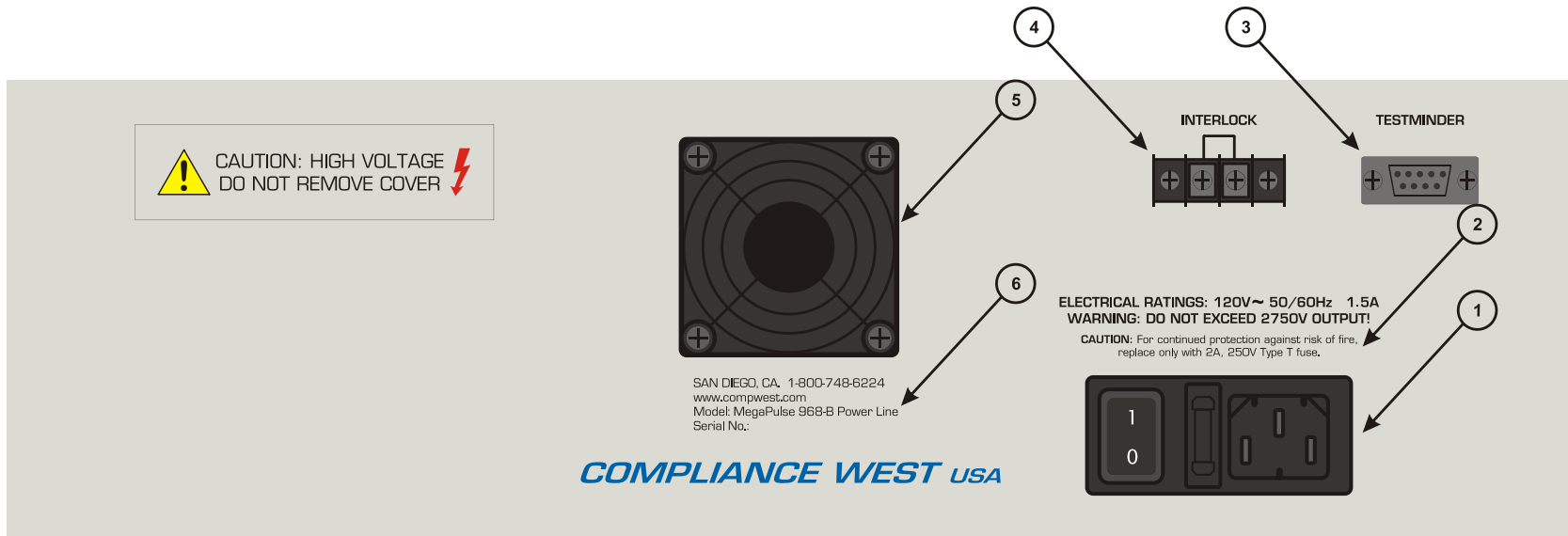

Figure 3 MegaPulse 968-B Power Line Rear Panel

Table 3 MegaPulse 968-B Power Line Rear Panel features

ITEM NO.	NAME	FUNCTION
1	Appliance Inlet / Fuse holder / Power Switch	Use supplied cordset to connect the MegaPulse 968-B Power Line tester to an appropriate source of supply. Fuse holder provides access for Fuse replacement, and the Power Switch is used to turn the tester ON and OFF.
2	Fuse replacement warning / Rating of power supply	Specifies replacement fuse and required supply voltage.
3	RS-232 Interface (Optional)	Allow the communication between the tester and computer interface; a RS-232 to USB is available.
4	Interlock Switch (Optional)	Emergency Stop Close: Enables the tester buttons for operation. Open: Stops any process in the tester and disables the buttons. The TRIGGER and CHARGE Indicators will be blinking
5	Fan (Included in some models)	Designed to cool down the tester.
6	Manufacturer Information	Contains manufacturer contact information and specific model details.



Section 4

Operating Instructions

This section contains operating instructions for the Compliance West USA MegaPulse 968-B Power Line Tester.

- In case of trouble, the test can be immediately terminated at any time by turning the rear-panel power switch to the OFF position.
- Before the test can commence, the unit must be armed by pressing the **CHARGE** Button. The test will not begin until the **TRIGGER** Button is pushed.
- Voltage is discharged by a resistor bank within the MegaPulse tester upon test completion. Discharge progress is shown on the front panel meter.

Your tester is warranted for a period of one year upon shipment of the instrument to the original purchaser.

External Interlock

The external interlock is a two-position terminal block located on the rear panel. When the External Interlock is open:

- TRIGGER and CHARGE lights will be blinking.
- The front keyboard will be disabled.
- If the unit is connected to a computer with the TestMinder software, the interlock status will be shown on the computer, condition that will also disable polarity changes, charge, and trigger conditions.

When the Interlock is closed, it enables all normal operations of the MegaPulse features.

Front Keyboard and Voltage Knob Enable

If the MegaPulse 968-B Power Line Tester has disabled the keyboard or Voltage Knob, it is possible to enable them by using the next keyboard sequence:

1. Turn OFF the MegaPulse P tester.
2. Press and hold the **TRIGGER** and **NOR-REV** buttons.
3. Turn ON the MegaPulse tester.
4. Wait until the display shows rESE.
5. Release the TRIGGER and NOR-REV buttons.

Discharging Residual Voltage

Note that the Voltage meter may indicate that some residual voltage is present on the main storage capacitor, even when the MegaPulse tester is first turned ON. This is due to inherent charging of the internal capacitors. The following procedure will explain how to discharge a remaining voltage stored on the main internal capacitor.

CAUTION

High voltage generated by the MegaPulse tester is exposed during this test. A risk of shock exists. Exercise care when using the MegaPulse unit.

1. Turn the rear-panel Power Switch OFF.
2. Disconnect the high voltage cables from the outputs connector.



3. Turn the rear-panel Power Switch ON.
4. Press the red **TRIGGER** button to discharge the main capacitor into the internal resistor of the MegaPulse unit.
5. Turn the rear-panel Power Switch OFF.

Voltage Set Point Adjustment

NOTE

If the front display shows the word “Off” when trying the adjustment, it means the front Voltage knob has been disabled by the Testminder software. See section “Front Keyboard and Voltage Knob Enable”

To adjust the Voltage Set Point:

1. Press the VOLTAGE Adjust knob one time to enable the adjustment mode, digits for thousands and hundreds will start blinking for a few seconds.
2. While the digits are still blinking, turn the VOLTAGE Adjust knob, clockwise or counterclockwise, to change the value of the blinking digits.
3. While digits are still blinking, press the VOLTAGE Adjust knob again and the tens and unit digits will start blinking for a few seconds.
4. While the digits are blinking, turn the VOLTAGE Adjust knob, clockwise or counterclockwise, to change the value of the blinking digits.
5. After a few seconds without any change on the VOLTAGE Adjust knob, the desired output voltage will be set.

Charge and Trigger a Pulse

The following procedure will explain how to generate a high voltage pulse with the MegaPulse unit. The MegaPulse 968-B Power Line Tester is capable to maintain a specific voltage charge selected by the Voltage Set Point.

CAUTION

High voltage generated by the MegaPulse tester is exposed during this test. A risk of shock exists. Exercise care when using the MegaPulse unit.

1. Confirm the Voltage Set Point by pressing the VOLTAGE Adjust Knob, the current setting will blink for a few seconds on the front meter.
2. If a different Voltage Set Point is needed it, refer to section “Voltage Set Point Adjustment.”
3. Push the yellow CHARGE button to start charging the internal high voltage capacitor and wait until the front meter reaches value set on Steps 1 or 2. Verify that the red TRIGGER indicator is now lit.
4. Once the desired voltage is reached, press the red **TRIGGER** button to deliver the high voltage pulse (be sure not to touch the output and return leads when pressing the trigger switch).
5. Turn the rear-panel Power Switch OFF.

Pulse Verification Procedure

The following procedure will verify that the high voltage pulse is properly generated by the MegaPulse tester. We recommend that this procedure be conducted periodically to ensure proper operation of the tester. The following items are needed to conduct this procedure:

- High voltage oscilloscope probe (1000:1)
- Digital Oscilloscope

Always ensure that the measuring instruments are rated for the voltage and frequency response involved. A digital oscilloscope or probe with a low frequency response will result in erroneous readings that could be misread.



CAUTION

High voltage generated by the MegaPulse tester is exposed during this test. A risk of shock exists. Exercise care when using the MegaPulse tester.

1. Turn the rear-panel Power Switch OFF.
2. Disconnect all high voltage cables from the output.
3. Turn the rear-panel Power Switch ON. If residual voltage is shown on LED display:
 - a. Press the red **TRIGGER** button to discharge the main capacitor into the internal resistor of the MegaPulse unit.
4. Set the Voltage Set Point to 1500V, see section “Voltage Set Point Adjustment.”
5. Plug the Output and Return test leads into the jacks on the front panel.
6. Connect the ends of the test leads to the measuring instrument. See **Error! Reference source not found.** for an example.
7. Set the next capturing setting on the digital oscilloscope to capture the high voltage pulse:
 - a. Vertical Scale = 500V / div.
 - b. Horizontal Scale = 4 μ s / div
 - c. Trigger Level = +500V
 - d. Slope transition “Low to High.”
 - e. Set “High Frequency Reject” mode.
 - f. Set “Single Pulse” capture mode.
8. Press the Charge button and wait until voltage reaches 2500V.
9. Press the Trigger button to deliver the pulse (be sure not to touch the output and return leads when pressing the trigger switch).
10. Verify the amplitude of the positive pulse captured on the digital oscilloscope:
 - a. V_{peak} 2500V.

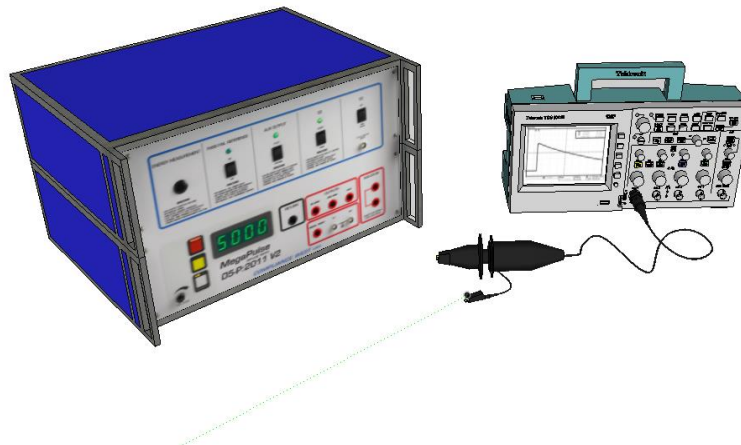

Figure 4 Waveform Measurement Setup - Image for reference only.



Section 5

Maintenance and Calibration

WARNING

THESE SERVICE INSTRUCTIONS ARE FOR USE BY QUALIFIED PERSONNEL ONLY. TO AVOID ELECTRIC SHOCK, DO NOT PERFORM ANY SERVICING OTHER THAN THAT CONTAINED IN THE OPERATING INSTRUCTIONS UNLESS YOU ARE QUALIFIED TO DO SO.

This section of the manual contains maintenance information for the MegaPulse series impulse tester. This maintenance information is divided into service information, general maintenance, a performance test, and a calibration procedure. The performance test is recommended as an acceptance test when the instrument is first received, and later as a preventative maintenance tool to verify proper instrument operation. A 1-year calibration cycle is recommended to maintain the specifications given in Section 3. The test equipment required for the performance test is an oscilloscope and high voltage probe, and a calibrated current shunt. The test equipment required for the calibration procedure is a DMM able to read the maximum specified peak output voltage of the MegaPulse tester.

Service Information

The MegaPulse tester is warranted to the original purchaser for a period of 1 year. This warranty does not cover problems due to misuse or neglect.

Malfunctions which occur within the limits of the warranty will be corrected at no charge. Mail the instrument post paid to the manufacturer. Dated proof of purchase is required for all in-warranty repairs.

The manufacturer is also available for calibration and / or repair of instruments that are beyond their warranty period. Contact the manufacturer for a cost quotation. Ship the instrument and your remittance according to the instructions given by the manufacturer.

General Maintenance

Cleaning

CAUTION

Do not use aromatic hydrocarbons or chlorinated solvents for cleaning. These solutions will react with the plastic materials used in the instrument.

Clean the front panel and case with a mild solution of detergent and a damp sponge. Clean dust from the PWB with clean, dry, low pressure (<20 psi).

Performance Test and calibration verification

The performance test evaluates the performance of your instrument to ensure that the logic, lights and high voltage sections are working properly. This test is recommended for incoming inspection, as a preventative maintenance check, and to verify proper operation during the calibration procedure. It is not necessary to disassemble the instrument to conduct these tests. If the instrument fails any part of the performance test, repair is indicated.

Allow the instrument to stabilize and perform the test at an ambient temperature of 23°C ±5°C (73°F ±9°F).



1. Connect the Tester to a proper source of supply using the included 18 AWG power supply cord.
2. Plug the Output and Return test leads in to the jacks on the front panel.
3. Connect the ends of the test leads to an oscilloscope with a high-voltage probe. Note that the **RETURN** lead is referenced to the chassis of the MegaPulse tester.
4. Turn the Tester on. Toggle the **POLARITY** switch if necessary so that the **NOR** indicator is lit.
5. Note that the Voltage meter may indicate that some residual voltage is present on the main storage capacitor, even when the tester is first turned ON. This is due to inherent charging of the internal capacitors. Pressing the **TRIGGER** switch will discharge the capacitors (be sure not to touch the outputs and return leads when pressing the trigger switch).
6. Adjust the **VOLTAGE** using the voltage knob so that the front panel LED display is reading a voltage that is suitable for the measuring instrument that is being used - preferably close to the maximum output voltage of the MegaPulse tester.
7. Press the **CHARGE** button and, when the desired voltage is reached, push the red **TRIGGER** button, and view the resulting impulse waveform on the measuring instrument.
8. Evaluate the voltage waveforms (peak, rise and duration) that you captured, they should be within the tolerances mentioned in **Table 1**. If the measured waveforms are out of tolerances, then additional evaluation and/or repair of the MegaPulse tester is needed.
9. Note that the peak amplitude of the measured output waveform is proportional to the voltage that is read of the front panel of the MegaPulse, but it will not be the same amount, it will depend on the waveform calibration and tolerances, therefore, it is important to measure the peak amplitude of the output waveform and adjust the output of the MegaPulse accordingly.
10. Repeat steps 5 through 9, except this time toggle the **POLARITY** switch so that the **REV** indicator is lit. Note that the impulse waveform will now be a negative pulse, so it will probably be necessary to adjust the measuring instrument to get a proper reading.
11. Connect the Output and the Return test leads across an appropriate current shunt, so that the Output lead is connected to one end of the current shunt, and the Return lead is connected to the other end of the current shunt.
12. Connect the measuring instrument across the current shunt, keeping in mind that the Return lead is referenced to ground.
13. Toggle the **POLARITY** switch if necessary so that the **NOR** indicator is lit.
14. Press the **CHARGE** button and, when the desired voltage is reached, push the red **TRIGGER** button, and view the resulting impulse waveform on the measuring instrument.
15. Evaluate the current waveforms (peak, rise and duration) that you captured, they should be within the tolerances mentioned in **Table 1**. If the measured waveforms are out of tolerances, then additional evaluation and/or repair of the MegaPulse tester is needed.
16. Repeat steps 14 through 17, except this time toggle the **POLARITY** switch so that the **REV** indicator is lit. Note that the impulse waveform will now be a negative pulse, so it will probably be necessary to adjust the measuring instrument to get a proper reading.
17. Turn the rear-panel power switch OFF.

If the waveforms are out of tolerances, service is required. Remove the Tester from service and contact the manufacturer for servicing information.



Section 6

Technical Assistance

Technical Assistance from Compliance West USA is available:

Phone: (800) 748-6224

Hours: 8:30 AM - 4:30 PM Pacific Time.

Also available on our web site at: **www.compwest.com**

Contact:

Compliance West USA
650 Gateway Center Way Suite D
San Diego, CA 92102 USA.

Phone: (619) 878-9696

FAX: (858) 481-8527

